

Finder 930 series

Fully Automatic Raman Spectroscopy Analysis System

Zolix Instruments Co., Ltd.

Finder 930

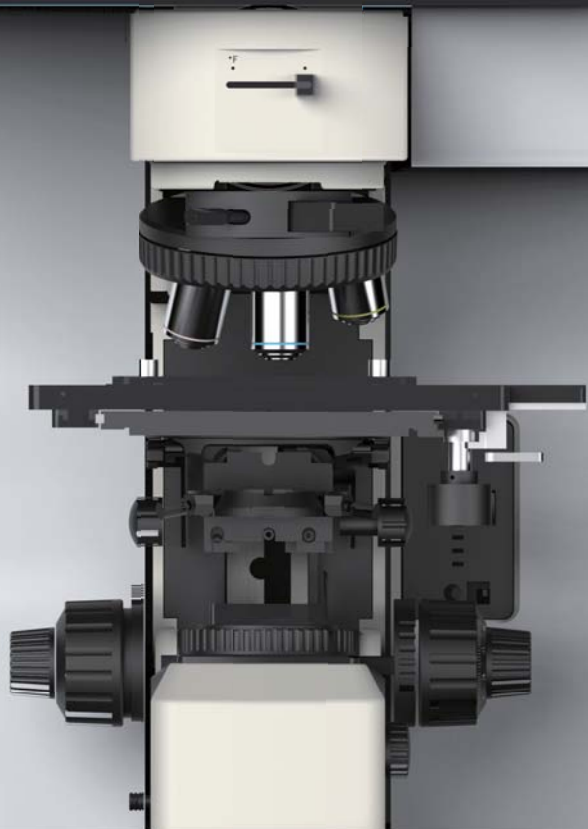

Raman Spectroscopy

Principle

Raman Spectroscopy is a scattering technique which analyzes the scattered light of different wavelength than the incident light to obtain the molecule structure of the analyte. When a incident laser light illuminate the sample, light collide material molecules and scatter. Most of the scattered light features the same wavelength with the incident light, only a very small amount scattered light (typically 0.0000001%) at different wavelengths with incident light, which is inelastic scatter called Raman scatter. The scattered light frequency less than incident light is called Stokes scattering, the scattered light frequency bigger than incident light is called Anti-Stokes scattering, they are symmetrically distributed on both sides of the Rayleigh scattering.

The frequency difference $\Delta\nu$ between the incident light and scattered light is called the Raman shift. Raman shift has no relationship with the incident light frequency, determined by the energy level structure of the material molecule, and different chemical bonds correspond one-to-one with the Raman shift, so the Raman spectrum is also considered to be the “fingerprint” of the material.

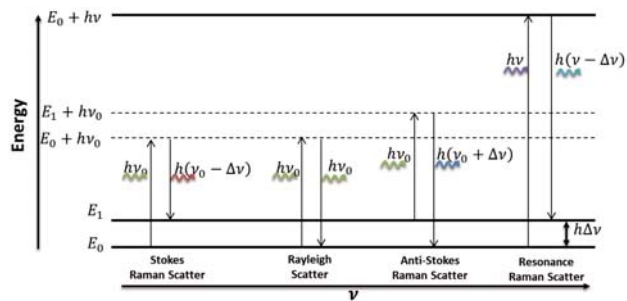
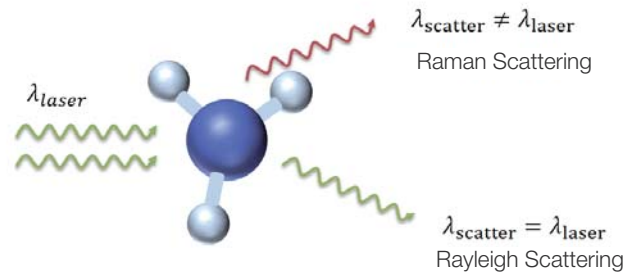

Advantage of the Raman spectrum

Molecule “Fingerprint”, identify the molecule structure and characteristic of the analyte

Non-destructive testing without sample marking

Simple sample preparation and measurement of samples containing water

Small amount of sample, detection spot less than 1 micron

High spatial resolution

High temperature and high pressure testing

Raman Spectroscopy Analytical Method

The intensity, frequency shift, line width, number of characteristic peak, and depolarization of Raman spectra are closely related to the vibrational energy state, rotational energy state, and symmetry of the molecule.

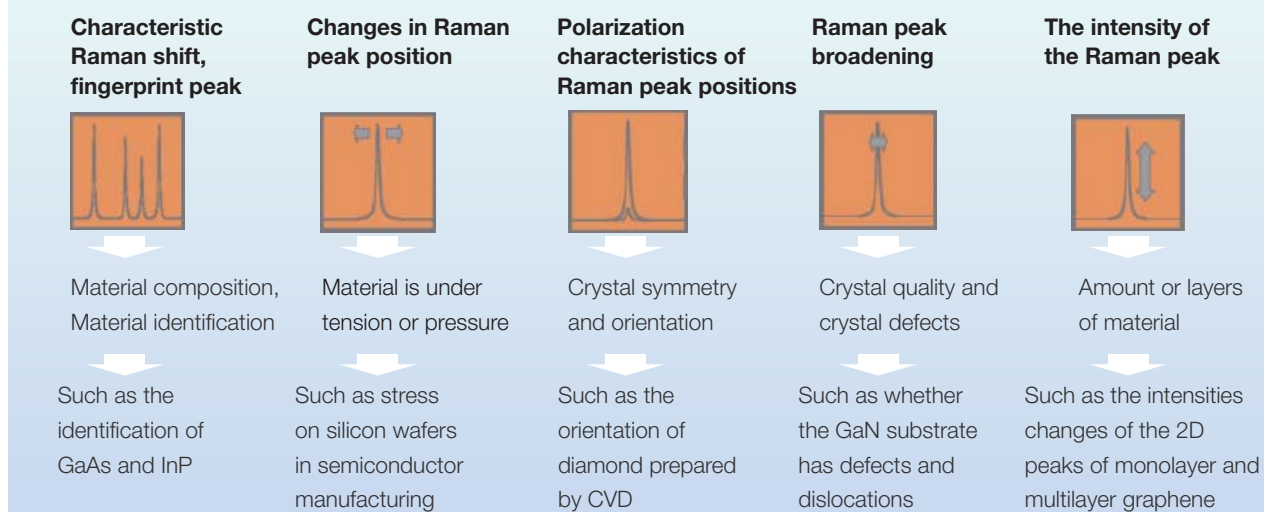

Sample Mapping Result

Sample: triangular MoS₂ nanosheets

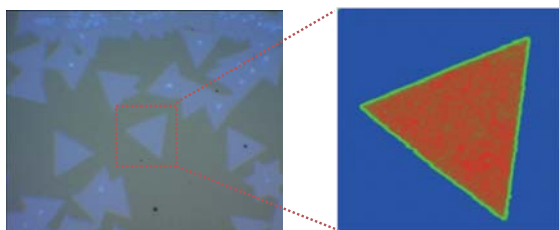

Measurement condition:

- Excitation light source: 532nm;
- Step size: 0.2μm;
- Microscope objective: 100X darkfield objective;

Sample: hexagonal MoS₂ nanosheets

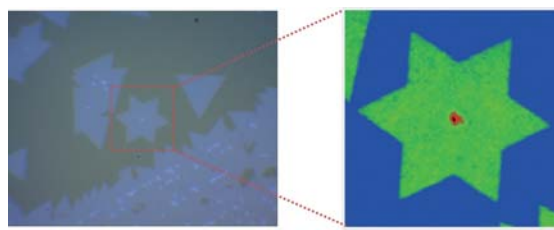

Measurement condition:

- Excitation light source: 532nm,
- Step size: 0.2μm,
- Microscope objective: 100X darkfield objective

Correlation imaging

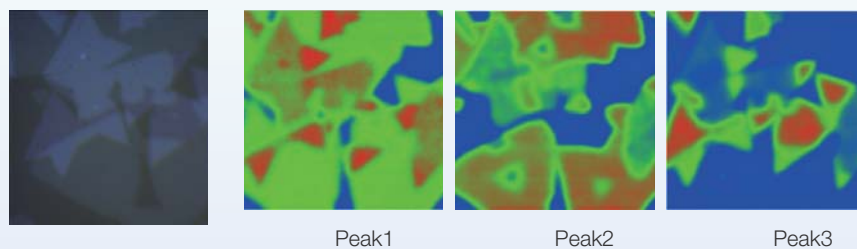

Measurement condition

- Sample: Heterojunction samples
- Excitation light source: 532 nm
- Step size: 0.2μm
- Test area: 32 × 32 μm
- Microscope objective: 100X darkfield objective

Sample: Rock Inclusions

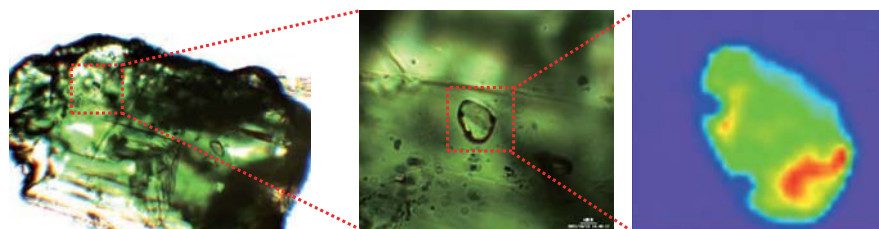

Measurement condition

- Excitation light source: 532 nm
- Microscope objective: 50X darkfield long focal length objective
- Step size: 0.5μm
- Scan area: 18 × 18 μm
- Integrating time: 1s

Product Overview

Since entering the field of Raman spectroscopy in 2003, Zolix has continued to accumulate technical strength, and continuously updated Raman products. The products have been widely used in materials, geology, biology, chemistry, medicine, food, investigate and other fields. After long-term discussions with customers in different industries, we have launched a new generation of Raman system: Finder 930, which aims to create a high-end laser confocal Raman spectrometer with high performance, high stability and high cost performance. Based on the successful experience of previous generations of products, Finder 930 has been fully upgraded in hardware and software:

- Using a new generation of image calibration spectrometer, the imaging quality is better, and the wavelength repeatability and accuracy are higher, making your experiment data more reliable.
- The high-precision automatic electric control system intelligently controls laser switching, laser power, confocal pinhole size, and automatic optical path correction not only makes the equipment more intelligent and easier to operate, but also greatly improve the stability, plug and play, and maintenance free.
- The new system software features fluorescence Mapping, Raman Mapping, fluorescence lifetime imaging, hyperspectral data processing, easy to use, making your data analysis more convenient and fast.
- The newly launched Finder 930 is a general analytical instrument with high performance, high reliability and high intelligence, and is a good helper for scientific research.

① Micro-Excitation Configuration :

Multi-lasers with switched by software (three lasers can be installed internal of the system, one laser can be installed external and reserve laser interface);

② Raman Microscope :

Upright microscope (Standard epi-illumination bright and dark field illumination, other illumination methods can be upgraded);

③ Motorized Sample Stage :

75x50mm travel and 1 μ m position accuracy;

④ Spectrograph :

Focal length 320mm imaging spectrometer with F/4.2, stray light 1×10^{-5} .

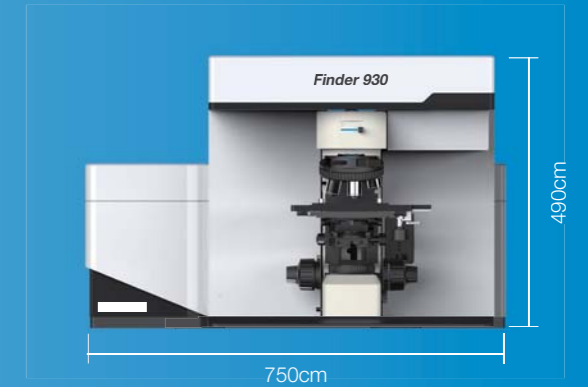

// Configuration

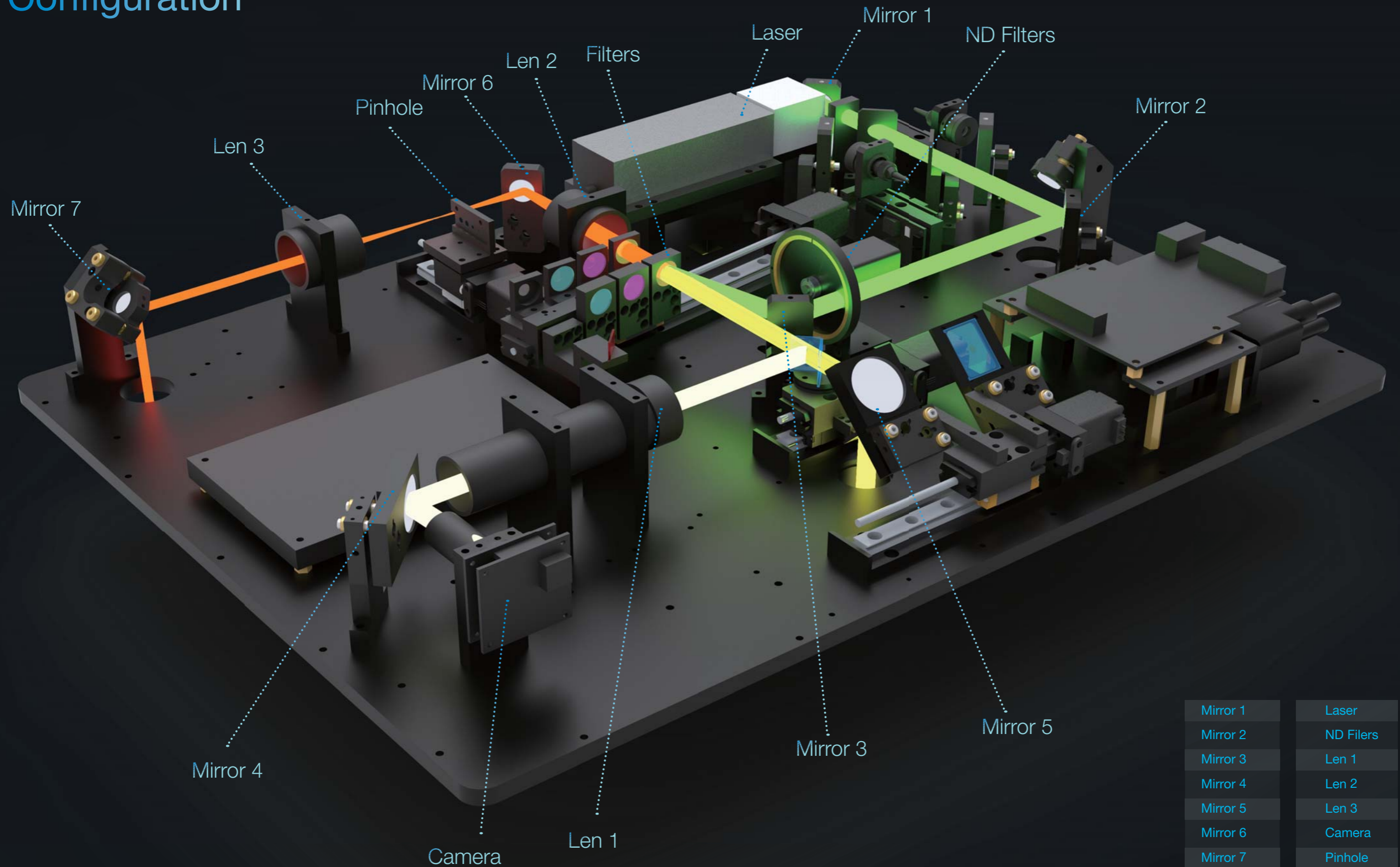

System Characteristic

High Confocal Performance

When a point light source (usually a laser) is focused on the sample through the objective lens, the image formed by this point is detected by the detector through the detection pinhole. At this time, the illumination pinhole and the detection pinhole are conjugate with respect to the focal plane of the objective lens, which is confocal. In confocal microscopy, only the scattered light signal of the illuminated sample will be accepted, which ensures lateral spatial resolution; while the signal of the sample located in the illuminated area of the light source but not on the focal plane will be defocused due to defocusing. The probed pinhole (spatial filter) is strongly attenuated, which also ensures longitudinal spatial resolution. Therefore, when we move the sample up and down along the direction of incidence of the laser, we can focus the laser on different layers of the sample to achieve section analysis of the sample. Another advantage of confocals is that they have better background suppression for transparent, translucent samples, or samples with strong fluorescence and blackbody radiation backgrounds.

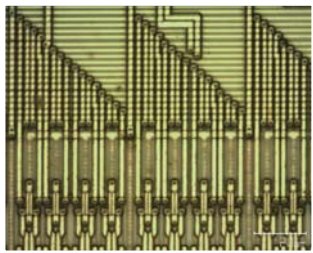
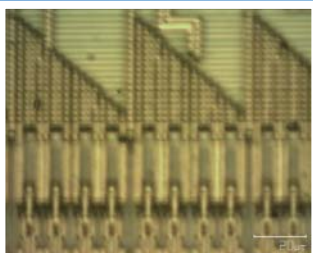
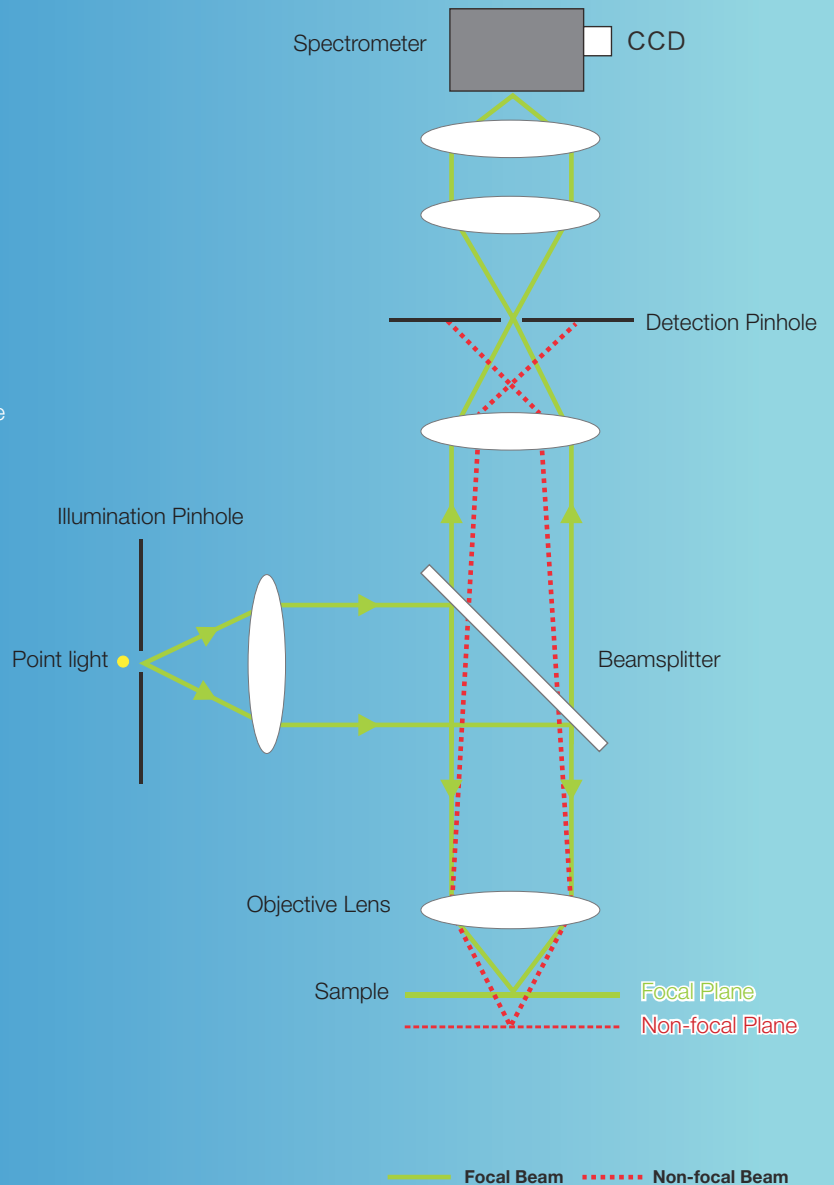

In widefield imaging (A), out-of-focus light can significantly reduce image resolution and contrast; however, in confocal imaging systems (B), pinholes are used to remove defocused light, resulting in higher contrast and resolution image.

High system stability

The confocal Raman system has high requirements on the stability of the light spot, and the drift of the light spot will seriously affect the performance of the system. Therefore, ensuring the stability of the system is the primary issue.

1.The effect of temperature and humidity on stability

The temperature and humidity will deform the optical mount and cause the spot to drift, the longer the optical path, the greater the drift. In order to solve this problem, Finder 930 adopts the built-in laser, which minimizes the optical path, and at the same time uses the aviation aluminum optical mount that is minimally deformed by temperature and humidity.

2.The effect of optical path switching on stability

For a multi-channel laser system, there are high requirements for positioning accuracy and repeatability, normally a motorized stage is used to switch the laser light path. Finder 930 cleverly combines multiple lasers through dichroic mirrors without motorized stage. When replacing lasers, only the lasers need to be switched on and off, avoiding the effect of the motorized stage on the optical path of the system.

Excellent Spectrum Imaging Capabilities

Raman Mapping can intuitively reflect the molecular properties of substances with high spatial resolution and fast imaging speed.

1. Spatial Resolution:

Lateral (XY) and Longitudinal (Z); Lateral resolution can be affected by objective NA, laser wavelength, pinhole size and laser beam quality; Longitudinal resolution is the confocal performance we are talking about. In addition to the above factors, it also has a great relationship with the optimal design of the system. This Raman System Finder930: Lateral resolution will be 0.5 μ m and Longitudinal resolution 1.79 μ m when 532nm laser with 100X, 0.9NA objective;

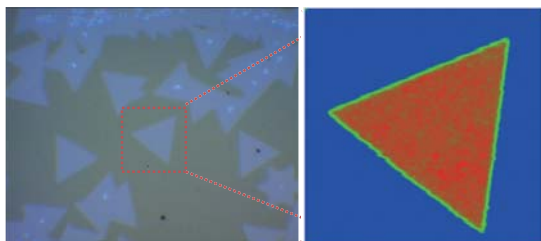

2. Mapping Imaging Speed

Mapping imaging speed is very important parameter which mainly depends on system sensitivity, motorized accuracy and software processing. The sensitivity will be higher enough, the acquisition time of single spectrum will be shorter, and the mapping speed can be improved; High precision motorized stage will prevent image distortion; The software mapping logic will improve mapping speed with the synchronization function and software real-time processing such as noise suppression and background subtraction can extract Raman spectra from weak signals and complex signals for real-time display.

Software Analysis

With powerful data analysis software, the Mapping data can be pre-processed such as de-baseline and smoothing, and then can be imaged through the integration, average, and maximum values of signal intensity according to requirements; in addition, single-peak and multi-peak Perform data fitting. For the output image, beautification processing such as color table matching can be performed.

Browsing Data

Browsing data and View single-point data information, display spectral curves at different positions; zoom in on local images;

Drag the mouse to enlarge the image

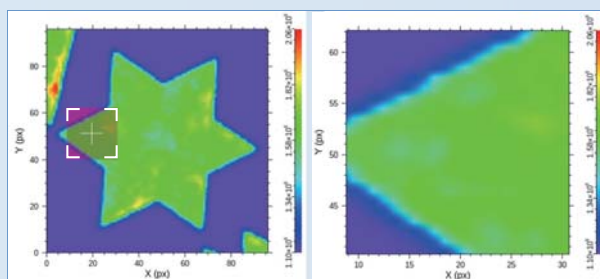
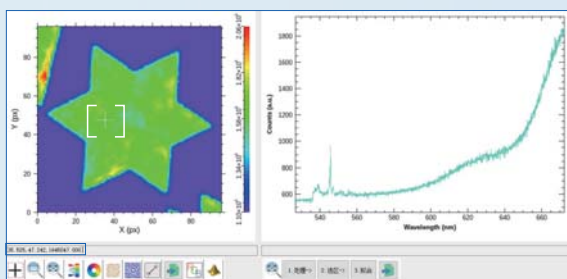

Support changing image color contrast

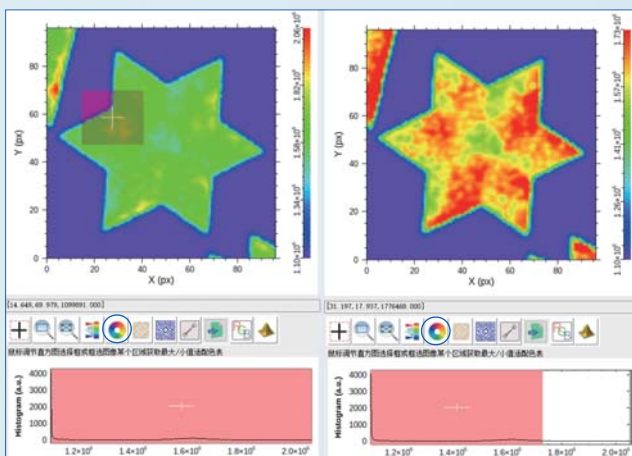

Color Table

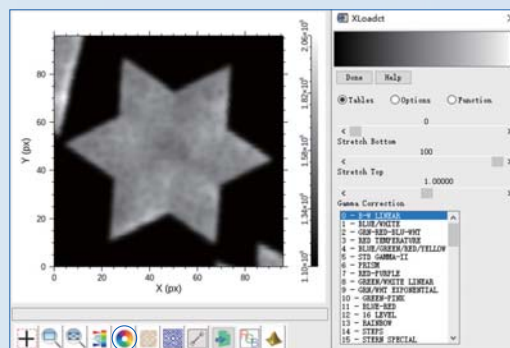

Difference Display

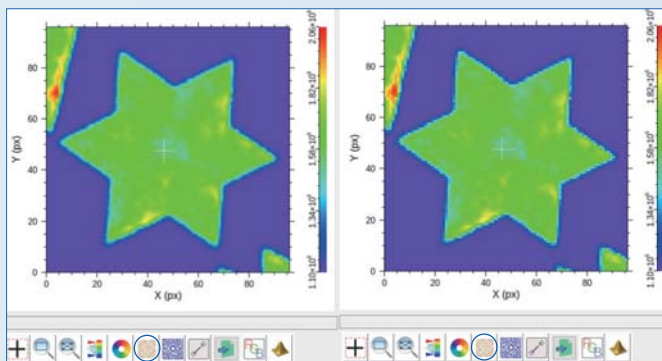

Contour display

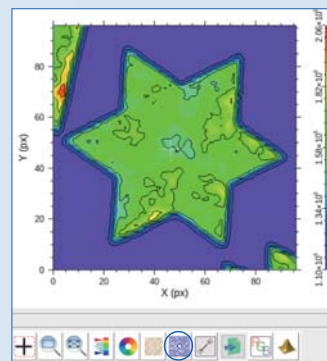

Mapping data processing

Single point (full image) data can be preprocessed, including removing "cosmic rays", spectral bases, smoothing spectral curves, etc.;

Remove "Cosmic Rays"

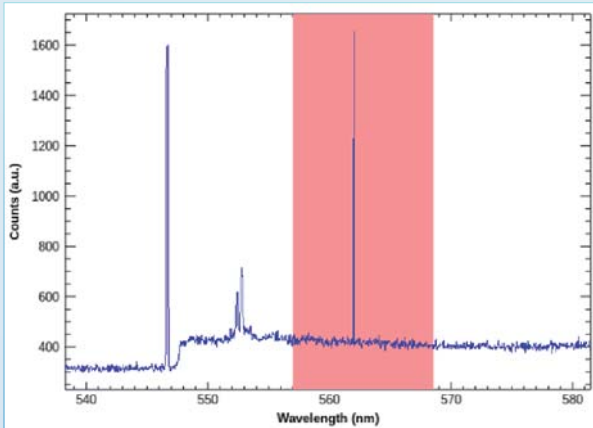

1. 处理-> 2. 选区-> 3. 拟合

1. 预处理数据

当前曲线去本底...	平滑当前曲线	当前曲线去杂线	当前曲线选定区域去接谱台阶
全图曲线去本底...	平滑全图曲线	全图曲线去杂线	全图曲线选定区域去接谱台阶
	平滑窗口宽度 >		台阶阈值 >

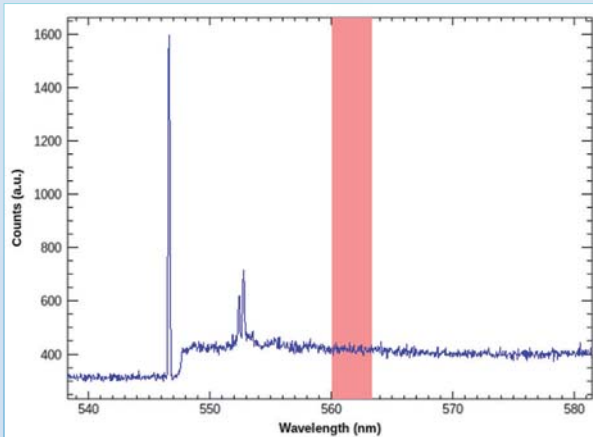

1. 处理-> 2. 选区-> 3. 拟合

1. 预处理数据

当前曲线去本底...	平滑当前曲线	当前曲线去杂线	当前曲线选定区域去接谱台阶
全图曲线去本底...	平滑全图曲线	全图曲线去杂线	全图曲线选定区域去接谱台阶
	平滑窗口宽度 >		台阶阈值 >

Remove Background Noise

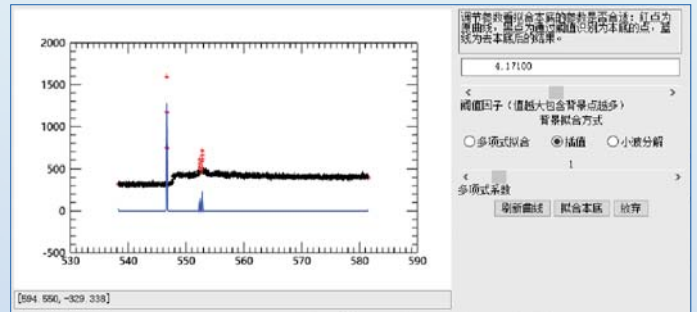

Spectrum Smoothing

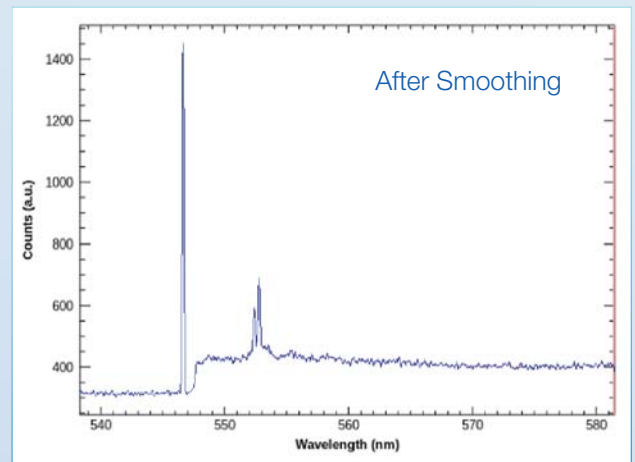
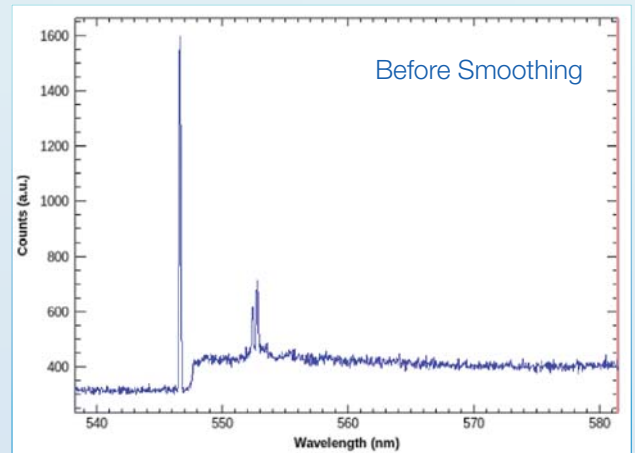

Spectral data fitted image display

After the preprocessing is completed, the spectrum of each point can be processed by the methods of integral value, average value, maximum value, minimum value, maximum value position, and minimum value position to obtain an image.

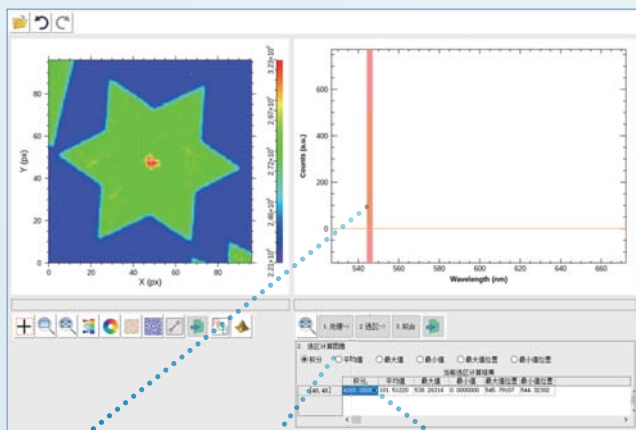

The frame is used to select a segment of the spectrum

Choose different ways to form the left image

The table display the information of the selected spectrum

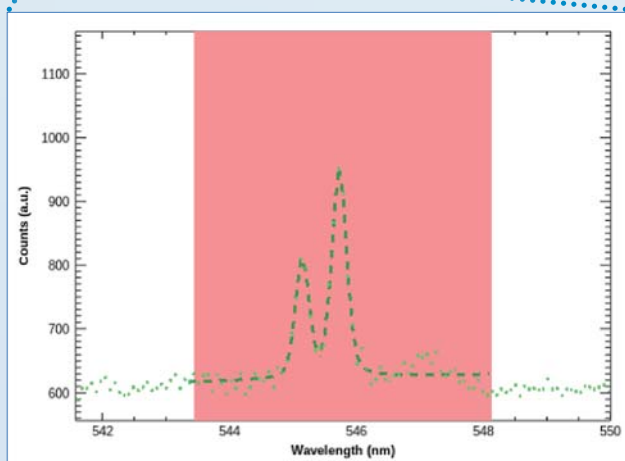

1. 处理-> 2. 选区-> 3. 拟合

3. 峰形拟合
 线型选择: Gauss-Lorentz | 本底阶数: 1阶(线性) | 峰个数: 2 | 峰/谷: 峰

拟合当前曲线 | 拟合所有曲线 | 图像显示: 峰高(1)

拟合结果								
峰高(1)	峰位(1)	半高宽(1)	比例因子(1)	峰高(2)	峰位(2)	半高宽(2)	比例因子(2)	
[43, 40]	186.05094	545.14718	0.25087942	0.71279522	330.94074	545.72957	0.26832239	0.60022070

The single-point spectral data can be fitted in different ways to obtain peak position, half-height width and peak height information, and can be used for image display.

3D image display

3D image can be rotated, translated etc.

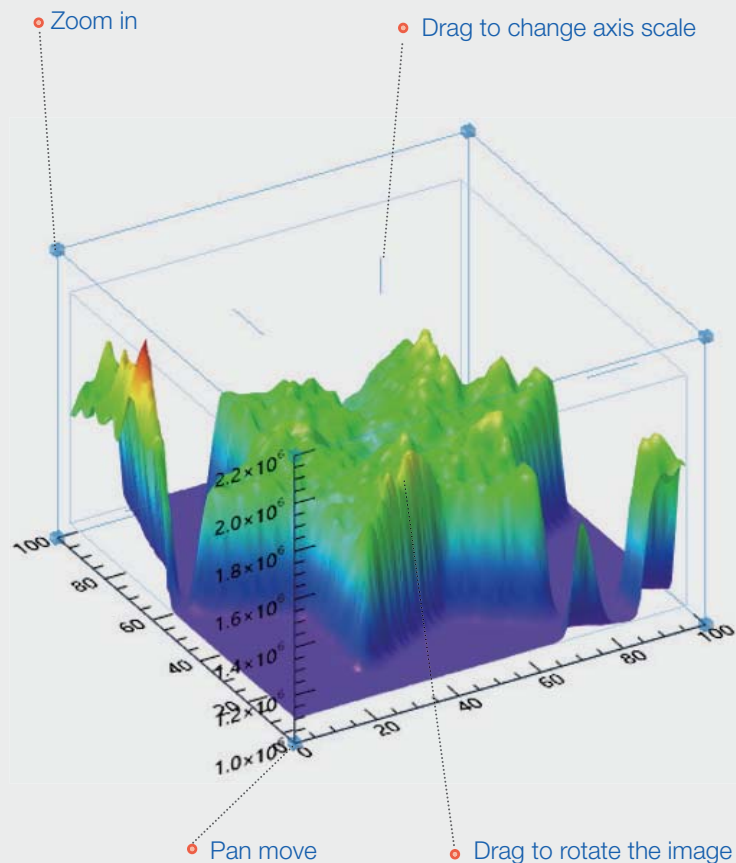

Accessories

Objective lens



Options

SLMPLN20X: Long working distance objective lens, NA 0.25, working distance 25mm, thread RMS;

SLMPLN50X: Long working distance objective lens, NA 0.35, working distance 18mm, thread RMS;

SLMPLN100X: Long working distance objective lens, NA 0.6, working distance 7.6mm, thread RMS;

LMU-15X-NUV: UV objective lens, spectral range 325-500nm, NA 0.3, working distance 8.6mm, thread RMS;

LMU-40X-NUV: UV objective lens, spectral range 325-500nm, NA 0.47, working distance 0.8mm, thread RMS;

LMPLN10XIR: Infrared objective lens, spectral range 700-1300 nm, NA 0.3, working distance 18mm, thread RMS;

LCPLN50XIR: Infrared objective lens, spectral range 700-1300 nm, NA 0.65, working distance 4.5mm, thread RMS;

LCPLN100XIR: Infrared objective lens, spectral range 700-1300 nm, NA 0.85, working distance 1.2mm, thread RMS;

Motorized Stage



- Motorized stage, travel range 70 × 50 mm, handle control;
- 1 μ m positioning accuracy, minimum step 50 nm;
- 2D Raman/PL Mapping
- Weight capacity 1kg

Cryostat



- Temperature range: -190 $^{\circ}$ C ~ 600 $^{\circ}$ C ;
- Temperature resolution: 0.01 $^{\circ}$ C ;
- Temperature stability: \pm 0.05 $^{\circ}$ C (> 25 $^{\circ}$ C) \pm 0.1 $^{\circ}$ C (< 25 $^{\circ}$ C);
- Maximum heating speed: + 150 $^{\circ}$ C /min;
- Maximum cooling speed: - 50 $^{\circ}$ C /min;
- Minimum objective lens distance: 5 mm;

Electrochemical accessories



Features:

- Raman, IR compatible
- Gas available
- Windows are optional
- Minimum focal length 1 mm

High pressure

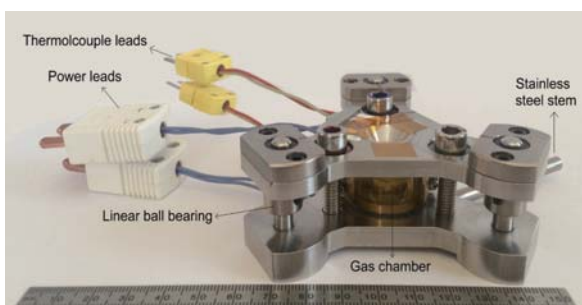

- Temperature range: Room temperature to 1000°C
- Temperature accuracy: $\pm 0.1^\circ\text{C}$
- Heating speed: 0.1 to 150°C /min
- Pressure range: Atmospheric pressure to 3GPa;
- Low temperature range: -100°C

In situ stretching device

It is a test device that stretching sample for infrared, ultraviolet and fluorescence research.

- Stretch adjustment range: 0.1-20 mm;
- Tension adjustment range: 1-100N, accuracy is about $\pm 0.3\%$ of full scale;
- Other tension ranges available.

On-site verification

1 Spatial resolution

Longitudinal Resolution

Test configuration :

- Sample: Silicon Wafer
- Step size: 0.25 μm
- Integral time: 0.3s
- Laser: 532nm
- Grating: 600g/mm@500nm
- Objective: 100X dark-field objective
- Slit: 100 μm
- Pinhole: 50 μm &400 μm
- Resolution: 1.79 μm @ pinhole 50 μm ;

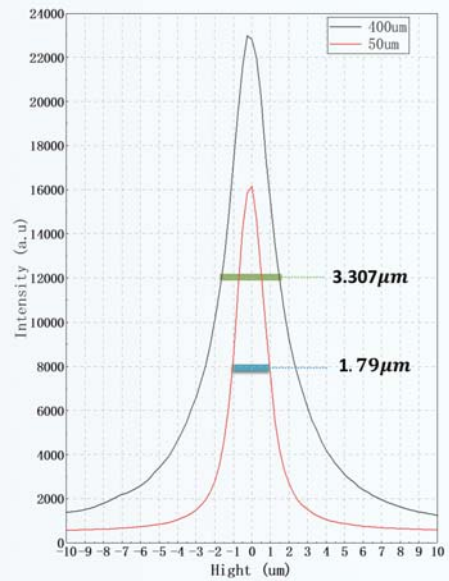
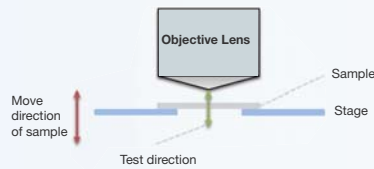

Lateral Resolution

Test configuration :

- Sample: Monolayer Molybdenum Disulfide
- Step size: 0.2 μm
- Integral time: 0.5s
- Laser: 532nm
- Grating: 600g/mm@500nm
- Objective: 100X dark-field objective
- Slit: 100 μm
- Pinhole: 50 μm
- Resolution: A straight line is taken along the vertical direction at the edge of the Mapping image, and the lateral resolution of the instrument can be obtained by fitting this curve. After fitting the experimental data, the lateral resolution is ~458 nm.

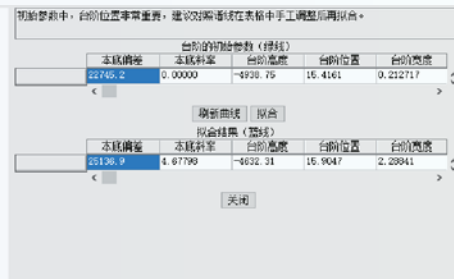
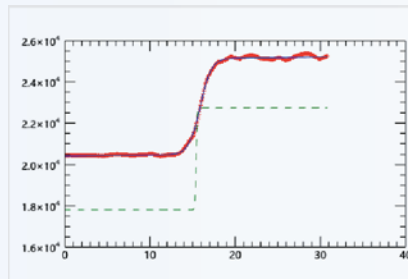
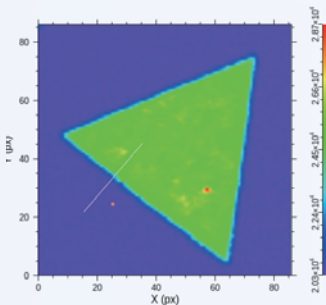

2 S/N (Signal of Noise)

Test configuration :

- Sample: Silicon wafer
- Integral time: 300s, Accumulate points once
- Laser: 532nm
- Grating: 600g/mm@500nm
- Objective: 100X dark-field objective
- Slit: 100 μ m
- Spectrum range: 1100-2500 cm^{-1}
- Test result: Test silicon third order and four-order raman at pinhole 50 μ m, the S/N of third order raman is 35:1;

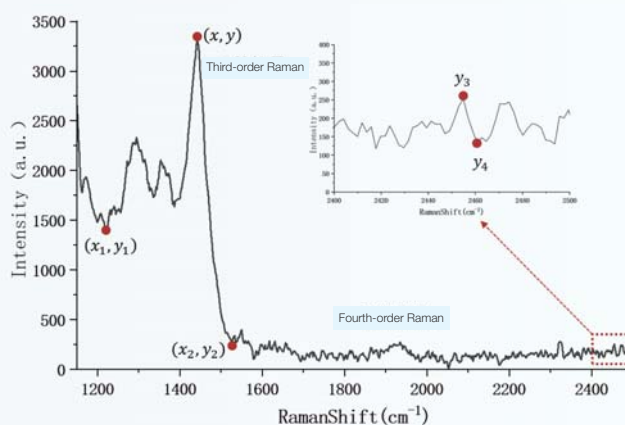

3 Spectral Resolution

Test configuration :

- Light source: Neon @585.25nm
 Grating: 1800g/mm@500nm
 Objective: 100X dark-field objective
 Slit: 10 μ m
 Pinhole: 50 μ m
 Spectrograph focal length: 320mm
 Test result: 1.025 cm^{-1}
 Spectrum resolution (FWHM) : $\leq 1.5\text{cm}^{-1}$, Typical; 2 cm^{-1} guarantee

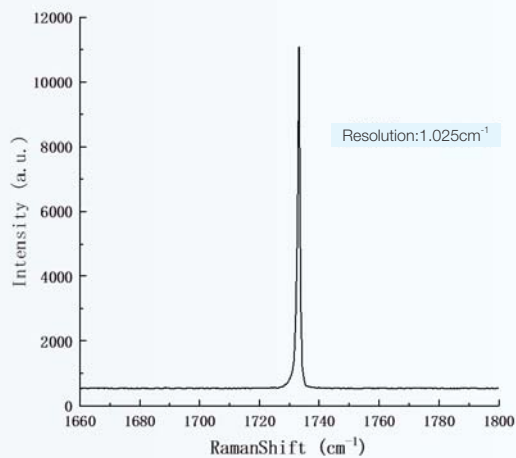

System Technical Information

Laser wavelength(nm)	Standard 532nm, optional 638nm、785nm
Laser power(mW)	>60 (532nm) ,>25 (638nm) ,>50 (785nm)
Raman shift(cm ⁻¹)	80-9000@532nm, 80-6000@638nm, 80-3200@785nm
Microscopy	Upright
Sample holder	Standard: manual with travel 102*105mm
	Optional: motorized with travel 75*50mm
Objective	10x, 50x(telephoto), 100x, (all are semi-apochromatic)
Epi-illumination	halogen lamp
Spectrograph	320 mm focal length, Czerny-Turner
CCD	2000x256 pixel, QE>90%, VIS to NIR
Grating	1800g/500nm blazed
	600g/500nm blazed
	150g/500nm blazed
Spectral resolution	< 1.5cm ⁻¹
S/N	> 30:1
Spatial (pinhole 50μm, 532nm laser)	Longitudinal resolution: < 2μm
	Lateral resolution: < 500nm





Zolix Instruments Co.,Ltd.

Address: No.68B LDUV, Tongzhou District, Beijing, China 101102

Tel: +86 10 56370168

Fax: +86 10 56370118

Email : info@zolix.com.cn

